



Part number  
**CXF 4/2**



**Brief description:**

female insert, 4 poles (80A, 830V) + 2 poles (16A, 400V) + PE, screw terminal connection, size "77.27", CLASS inserts

Product description		Approvals / Standards	
<b>Model</b>	female insert	<b>Reference standard</b>	EN 61984:2009-06
<b>Version</b>	screw terminal connections	<b>Quality mark</b>	 DNV-GL, EAC
<b>Series</b>	CX	<b>Conformity</b>	CQC, CE
<b>Product type</b>	with female contacts	General ordering information	
<b>Family</b>	CLASS inserts	<b>EAN13 code</b>	8015747042338
<b>Size</b>	size "77.27"	<b>Tariff number</b>	85369095
<b>N. of poles</b>	4 poles + 	<b>Country of origin</b>	Made in EU (IT)
<b>Auxiliary poles</b>	2 poles (16A max - 400V/6kV/3)	<b>ETIM classification</b>	EC000438
Technical data		Packaging Information	
<b>Current</b>	80 A (A.C. and D.C.)	<b>Packaging length</b>	245,00 mm
<b>Voltage</b>	830 V	<b>Packaging height</b>	165,00 mm
<b>Rated impulse withstand voltage</b>	8 kV	<b>Packaging width</b>	215,00 mm
<b>Pollution degree</b>	3	<b>Packaging weight</b>	3,96 kg
<b>Wire cross-section</b>	4,00 mm <sup>2</sup> - 16,00 mm <sup>2</sup>	<b>Packaging volume</b>	8,69 dm <sup>3</sup>
<b>AWG size</b>	12 - 6	<b>Packaging description</b>	Carton box
<b>Operating temperature range (min, max)</b>	-40°C ... +125°C	<b>Packaging quantity</b>	30 Pcs
<b>Contact type</b>	silver plated	<b>Packaging EAN code</b>	8015747191845
<b>Mating cycles</b>	≥ 500	<b>Sub-packaging length</b>	87,00 mm
<b>IP degree of protection</b>	IP20 without enclosure, IP65/IP66/IP68/IP69 with enclosure	<b>Sub-packaging height</b>	36,00 mm
Further technical details		<b>Sub-packaging width</b>	180,00 mm
<b>Characteristics according to EN 61984</b>	80A 830V 8kV 3; 16A 400V 6kV 3; 16A 400/690V 6kV 2	<b>Sub-packaging weight</b>	0,66 kg
<b>Insulation resistance</b>	≥ 10 GΩ	<b>Sub-packaging volume</b>	0,56 dm <sup>3</sup>
<b>Contact resistance</b>	≤ 0,3 mΩ (4 poles), ≤ 1 mΩ (2 poles)	<b>Sub-packaging description</b>	Carton tray
<b>Rated voltage according to UL/CSA</b>	600V	<b>Sub-packaging quantity</b>	5 Pcs
<b>UL 94 flammability rating</b>	V-0	<b>Sub-packaging EAN barcode</b>	8015747042345
<b>Weight</b>	118,00 g		

Part number

**CXF 4/2**



## Catalogue drawings

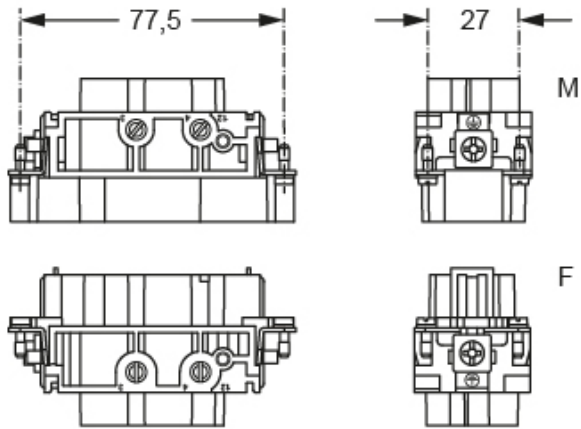

contacts side (front view)

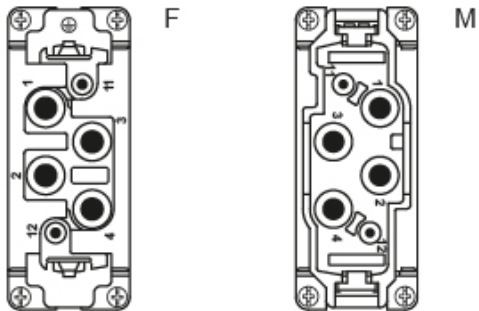

## Derating curves

CX 4/2 poles connector inserts  
Maximum current load derating diagram

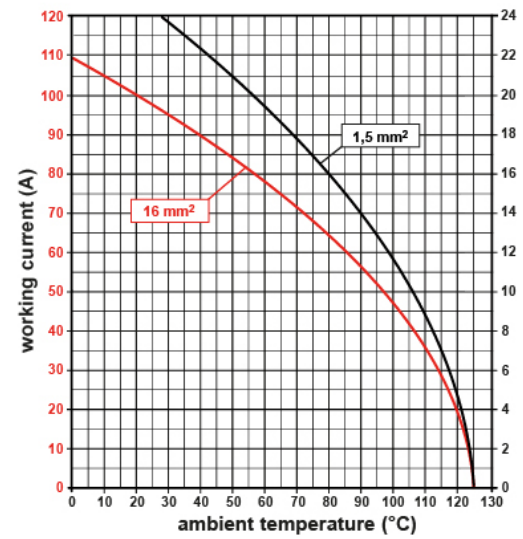
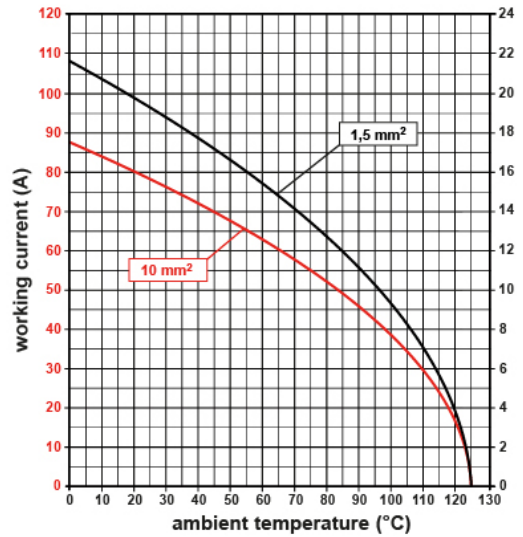
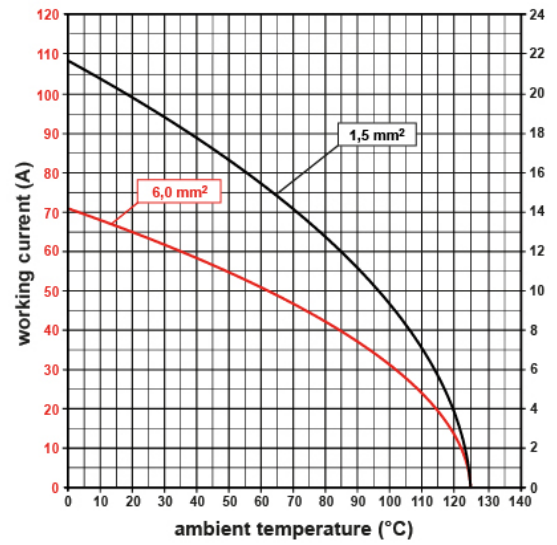

CXF/M 4/2 inserts

80A contacts

- without plate for section conductors:

4 - 16 mm<sup>2</sup> - AWG 12 - 6

- conductors stripping length: 14 mm

- terminal screw torque: 2.5 Nm

- characteristics according to EN 61984:

80A 690V 8kV 3

16A 400V 6kV 3

16A 400/690V 6kV 2

- rated voltage according to UL/CSA: 600V

- insulation resistance: > 10 GOhm

- ambient temperature limit: -40 °C ... +125 °C

- are made of self-extinguishing thermoplastic resin UL 94 V0

- mechanical life: > 500 cycles

- contact resistance: < 0,3 mOhm (4 poles) < 1 mOhm (2 poles)

- inserts for applications with temperatures up to 180 °C, available on request

- enclosures: size 77.27:

C-TYPE IP65/IP66

C7 IP67 stainless steel lever .

V-TYPE IP65/IP66

stainless steel lever

T-TYPE IP65 insulating

JEI zinc-plated steel lever

BIG hoods

aggressive environments

EMC

central lever

IP68

- panel supports: COB

---