

N3100B-0011

N Plug Crimp

75Ω

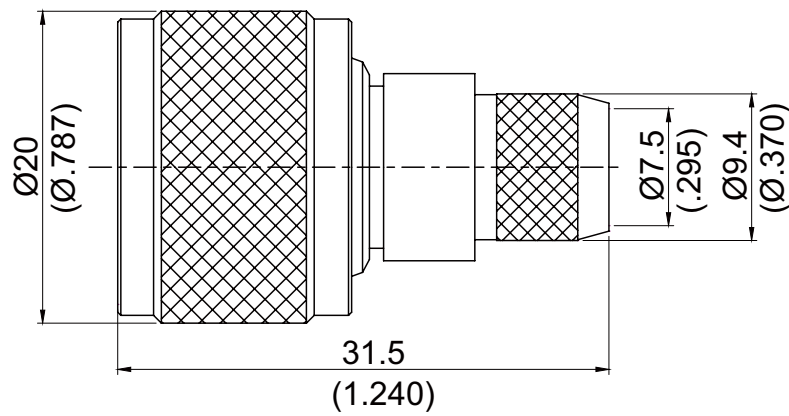

Parts	Material	Plating (Micro-inch)
Ferrule	Copper	Tin-Zinc-Copper-Alloy 100 Over Copper 50
Gasket	Silicon	
Contact Pin	Brass	Gold 4 Over Nickel Phosphorous Alloy 80 Over Copper 20
Insulator	Teflon	
Body	Brass	Tin-Zinc-Copper-Alloy 100 Over Copper 50
Coupling Nut	Brass	Tin-Zinc-Copper-Alloy 100 Over Copper 50

Weight:
Suitable Cables:RG11

This part number complies with RoHS.

CABLE ASSEMBLY INSTRUCTION

N3100B-0011

N3100B-0011

DATE

2014/04/29

REV

—

A

B

C

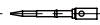
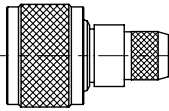

BODY

CONTACT PIN

FERRULE

DIAGRAM

ASSEMBLY INSTRUCTION

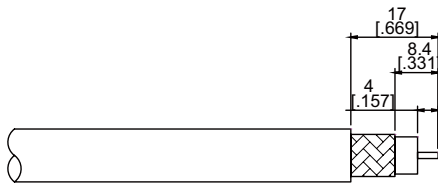

Step 1: STRIP AS SHOWN.

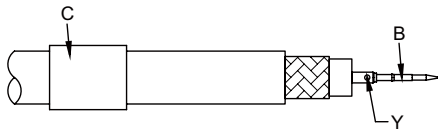

Step 2: SLIDE FERRULE " C " OVER CABLE.
Step 3: PUT PIN " B " ON CENTER CONDUCTOR AND SOLDER OR CRIMP IN " Y ".
(USE SQUARE 1.6mm/0.063inch SECTION OF INSERT-C IF CRIMPED)

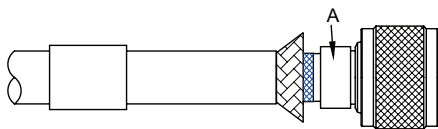

Step 4: LOOSEN BRAIDING AND SLIDE CONNECTOR " A " IN PLACE.

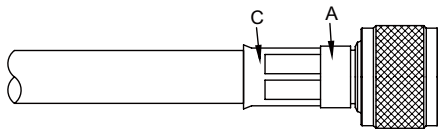

Step 5: SLIDE FERRULE " C " TOWARDS THE CONNECTOR " A " AND CRIMP.
(USE 10.7mm/0.421inch HEX SECTION OF INSERT-C)

This part number complies with RoHS.