

N3100B-0058

N Plug Crimp

50Ω

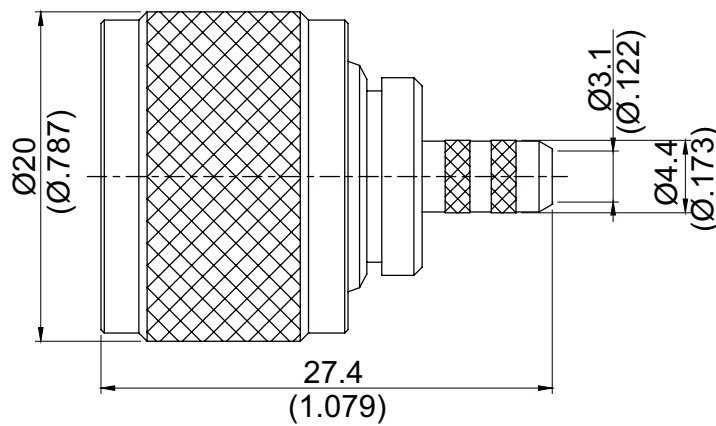



Parts	Material	Plating (Micro-inch)
Ferrule	Copper	Tin-Zinc-Copper-Alloy 100 Over Copper 50
Gasket	Silicon	
Contact Pin	Brass	Gold 4 Over Nickel Phosphorous Alloy 80 Over Copper 20
Insulator	Teflon	
Body	Brass	Tin-Zinc-Copper-Alloy 100 Over Copper 50
Coupling Nut	Brass	Tin-Zinc-Copper-Alloy 100 Over Copper 50

Weight:

Suitable Cables:RG58,JBY195,JBY195-LSFH

This part number complies with RoHS.

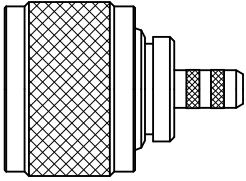
CABLE ASSEMBLY INSTRUCTION

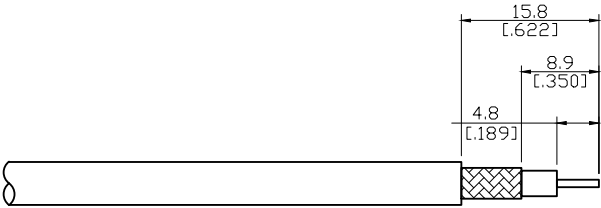
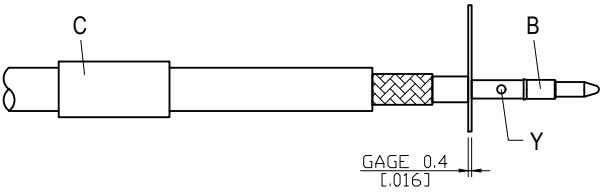
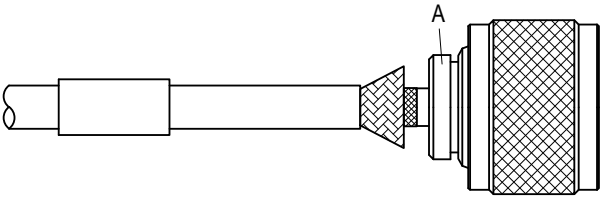
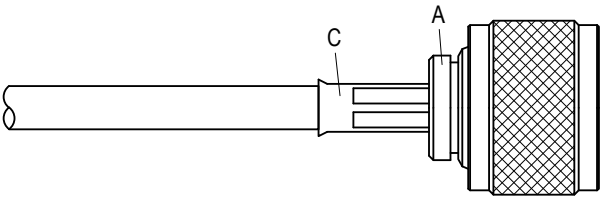
N3100B-0058	DATE	2018/02/13	REV	A
 <p style="text-align: center;">A</p> <p style="text-align: center;">BODY</p>	 <p style="text-align: center;">B</p> <p style="text-align: center;">CONTACT PIN</p>	 <p style="text-align: center;">C</p> <p style="text-align: center;">FERRULE</p>		
DIAGRAM	ASSEMBLY INSTRUCTION			
	<p>Step 1: STRIP AS SHOWN.</p>			
	<p>Step 2: SLIDE FERRULE " C " OVER CABLE. Step 3: PUT 0.4 MM GAGE IN PLACE, INSERT CABLE'S CENTER CONDUCTOR INTO CENTER PIN " B " AND SOLDER OR CRIMP IN " Y ". (USE SQUARE 1.6mm/0.063inch SECTION OF INSERT-B IF CRIMPED)</p>			
	<p>Step 4: LOOSEN BRAIDING AND SLIDE CONNECTOR " A " IN PLACE.</p>			
	<p>Step 5: SLIDE FERRULE " C " TOWARDS THE CONNECTOR " A " AND CRIMP. (USE 5.5mm/0.217inch HEX SECTION OF INSERT-B)</p>			

This part number complies with RoHS.