

Part number

MAP 10 L32



Surface mounting housing, C-TYPE series, with 1 lever, M32 cable entry, size "57.27", high construction

Product description

Product type	surface mounting housing
Series	C-TYPE
Closing type	with 1 lever
Size	size "57.27"
Cable entry	M32
Specification	high construction

Technical data

IP degree of protection	IP66 (and IP69 DIN 40050 - 9)
--------------------------------	-------------------------------

Further technical details

Weight	338,00 g
Operating temperature range (min, max)	-40 °C...+125 °C

Approvals / Standards

Certifications	DNV-GL, BV
-----------------------	------------

General ordering information

EAN13 code	8015747051163
-------------------	---------------

Packaging Information

Packaging length	475,00 mm
Packaging height	200,00 mm
Packaging width	150,00 mm
Packaging weight	3,38 kg
Packaging volume	14,25 dm ³
Packaging description	Carton box
Packaging quantity	10 Pcs
Packaging EAN code	8015747244398
Sub-packaging weight	1,69 kg
Sub-packaging description	Plastic packaging
Sub-packaging quantity	5 Pcs
Sub-packaging EAN barcode	8015747051170

Part number

MAP 10 L32



Catalogue drawings

CHP L - CAP L MHP L - MAP L

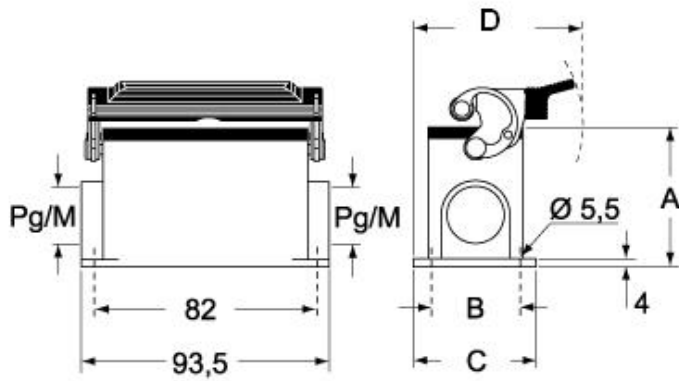

CHP LS - CAP LS MHP LS - MAP LS

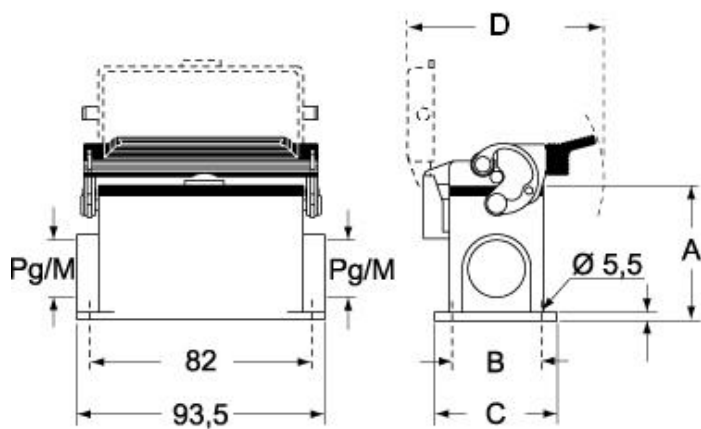

Notes

Dimensions shown in mm are not binding and may be changed without notice.