

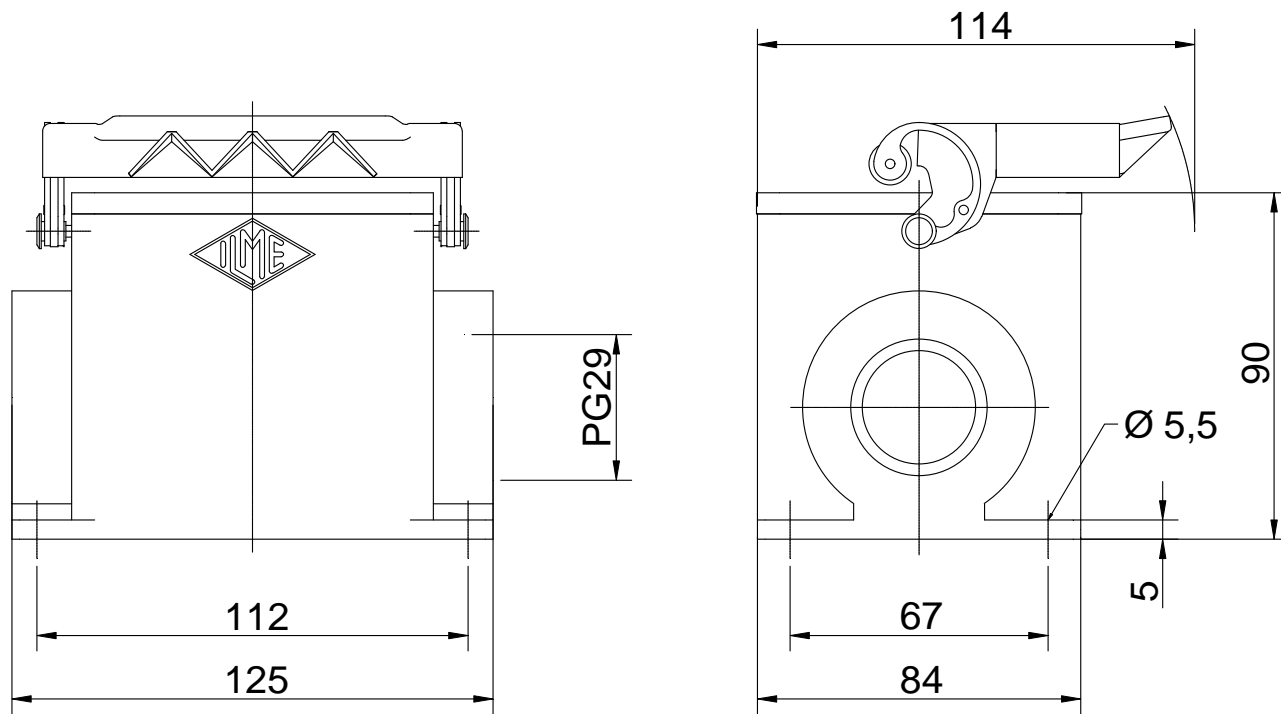

Diritti riservati All rights reserved



Date 04.01.2007	CHP 32 L29	Scale	
Sign.	surface mounting h. 1 lev. PG29	1:2	