

Part number

MKH VG25

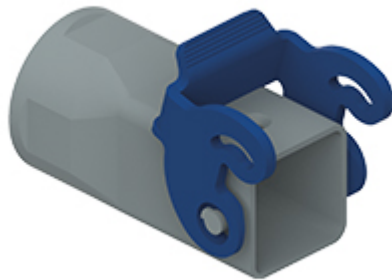

Hood, CKH series, with 1 lever, M25 top cable entry, size "21.21"

Product description

Product type	Hood
Series	CKH
Closing type	with 1 lever
Size	size "21.21"
Cable entry	top cable entry M25

Technical data

IP degree of protection	IP44 (IP66/IP67/IP69 with CKRH 65/CKRH 65 D kits)
--------------------------------	---

Further technical details

Operating temperature range (min, max)	-40°C...+70°C
---	---------------

Material properties

Main material	Polyamide (PA)
Other materials	Lever: polypropylene (PP)
Colour	RAL 7012 grey, RAL 5015 blue

General ordering information

EAN13 code	8015747275460
-------------------	---------------

Packaging Information

Sub-packaging description	Plastic bag
Sub-packaging quantity	1 Pcs
Sub-packaging EAN barcode	8015747280556

Part number

MKH VG25



Catalogue drawings

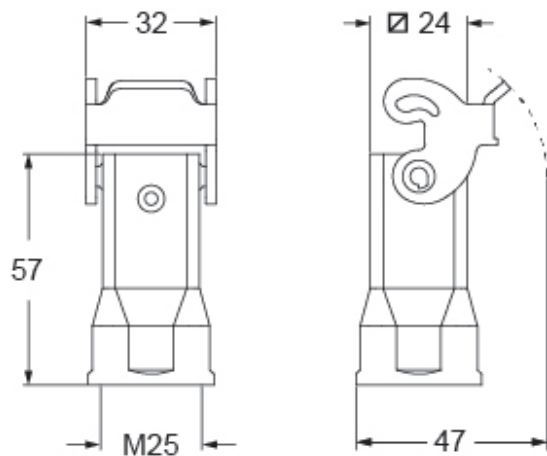

Notes

Dimensions shown in mm are not binding and may be changed without notice.