

Long-term behaviour of bare, bolted busbar joints

with and without the connecting element MC-SEALconTACT

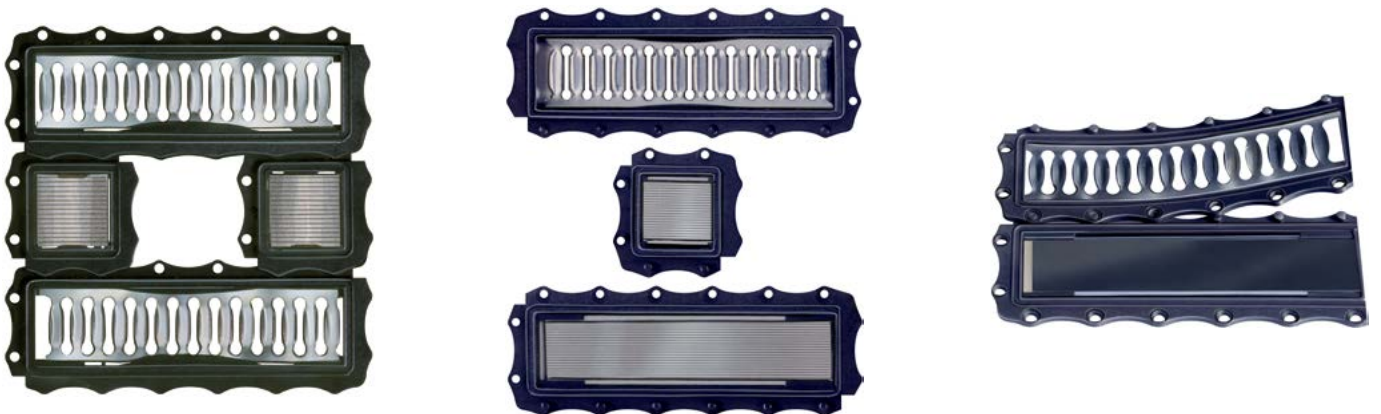

The use of the connecting element called MC-SEALconTACT reduces electrical losses, prolongs service life, and enhances the reliability of the entire installation

Contents

1.	Problem definition	3
2.	Evaluation and description of bolted busbar joints	3
2.1.	Joint resistance R_v	3
2.1.1.	Internal resistance R_b	3
2.1.2.	Constriction resistance R_e	3
2.1.3.	Impurity resistance R_f	3
2.1.4.	Contact resistance $R_{\bar{u}}$	3
2.2.	Busbar resistance R_{Sch}	3
2.3.	Resistance factor k_u	4
2.3.1.	Lowest possible resistance factor.....	4
2.4.	Factors affecting joint resistance R_v and resistance factor k_u	4
2.4.1.	Constriction resistance R_e and impurity resistance R_f	4
2.4.2.	Impurity film build-up	4
2.4.3.	Impurity film build-up and joint temperature	4
2.4.3.1.	Sources of heat, internal and external heat.....	4
2.4.3.2.	Overtemperature	4
3.	Economic and ecological aspects.....	5
3.1.	Technical reliability and maintenance of bolted busbar joints.....	5
3.2.	State-of-the-art bolted busbar joints.....	5
3.3.	Bolted busbar joints with the connecting element MC-SEALconTACT	5
3.3.1.	Functional properties of the connecting element MC-SEALconTACT	5
3.3.1.1.	Contact module with torsion-spring louvers	5
3.3.1.2.	Grooved support module	6
3.3.1.3.	Sealing frame for the contact and support modules.....	6
3.4.	Comparison of the resistance factors of bolted busbar joints with and without the connecting element MC-SEALconTACT.....	6
3.4.1.	Initial resistance factor k_{u0}	6
3.4.2.	Long-term resistance factor $k_u(t)$	7
3.4.2.1.	Without connecting element	7
3.4.2.2.	With connecting element.....	7
3.5.	Prospective energy cost savings at busbar joints with the connecting element MC-SEALconTACT in indoor applications.....	8
4.	Summary	9
5.	Literature references.....	9
6.	Appendix	
	Testing of the long-term resistance factor $k_u(t)$ of busbar joints with the connecting element MC-SEALconTACT.....	10

1. Problem definition

Wherever currents are transmitted in the order of a few hundred amps to a few thousand amps – or even tens of thousands of amps, as in the case of metal melting furnaces – problems arise at the busbar joints as a result of excessively high joint resistance.

Several variables affect this resistance, which increases with time because of aging. The heat losses rise at the same time. Ultimately, excessive heating can lead to total failure of the joint. Service life can vary widely depending on the ambient conditions.

2. Evaluation and description of bolted busbar joints

2.1. Joint resistance R_v

According to [1], the joint resistance R_v of a busbar joint, Figure 1, is the sum of several resistances as indicated by Equation 1.

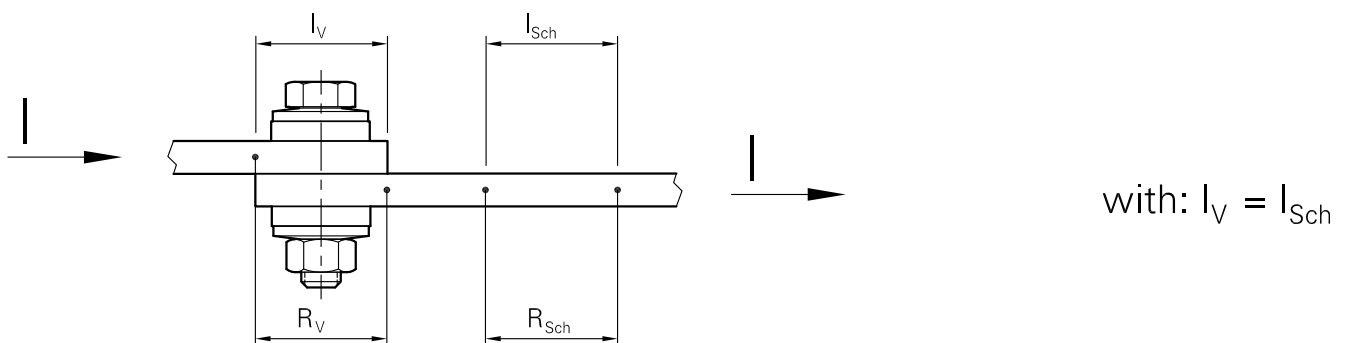

Figure 1
Joint resistance R_v and resistance factor k_u of bolted busbars
 $R_v = R_b + R_e + R_f$ (Equation 1)

2.1.1. Internal resistance R_b

R_b is the internal resistance of both busbars over the overlap length l_v , on the assumption that the busbars are joined metallicity homogeneously. In other words, where the contact resistance $R_{\bar{u}}$ according to Equation 2 equals zero.

2.1.2. Internal resistance R_e

R_e is the resistance created by the constriction and compression of the current flow pattern at the undefined contact points along the surfaces of the two busbars.

2.1.3. Impurity resistance R_f

R_f is the resistance of the impurity films that build up on the bearing contact surfaces.

2.1.4. Contact resistance $R_{\bar{u}}$

$R_{\bar{u}}$ is the sum of the constriction and impurity resistances.

$$R_{\bar{u}} = R_e + R_f \quad (\text{Equation 2})$$

2.2. Busbar resistance R_{sch}

R_{sch} is the resistance of a busbar section l_{sch} long, which is equal to the overlap length l_v .

2.3. Resistance factor k_u

As indicated by Equation 3, the resistance factor k_u is the ratio of the joint resistance R_v over the overlap length l_v to the busbar resistance R_{sch} of a busbar of equal length l_{sch} .

$$k_u = \frac{R_v}{R_{sch}} = \frac{U_v}{U_{sch}} = \frac{P_v}{P_{sch}} \quad (\text{Equation 3})$$

2.3.1. Lowest possible resistance factor

If a negligibly small contact resistance $R_{\bar{u}}$ is assumed, i.e. $R_{\bar{u}} = 0$, the joint resistance becomes

$$R_v = R_b \quad (\text{Equation 4})$$

The lowest theoretical value of the resistance factor k_u then becomes

$$k_u = 0,5 \quad (\text{Equation 5})$$

2.4. Factors affecting joint resistance R_v and resistance factor k_u

2.4.1. Constriction resistance R_e and impurity resistance R_f

It can be seen from Equations 1 and 2 that the joint resistance R_v is lowest when contact resistance $R_{\bar{u}}$ is 0. Consequently,

- the larger the current-conducting contact area, and therefore the lower the constriction resistance R_e , and
- the thinner the poorly conducting or nonconducting impurity film and therefore the lower the impurity resistance R_f , the better the quality of the busbar joint.

2.4.2. Impurity film build-up

When current flows at the contact points, the respective electrons have to exit one busbar and enter the other. The microstructure of the busbar surfaces and the thicker or thinner impurity films are extremely important in this respect.

The contact resistance $R_{\bar{u}}$ and therefore the joint resistance R_v increases with time as a result of impurity film build-up caused

by chemical reactions, e.g. oxidation and corrosion. The busbar material can react with the ambient atmosphere or with the contamination and harmful gases it contains. Surfaces free of impurity films are achievable only in high vacuum.

2.4.3. Impurity film build-up and joint temperature

Progressive film build-up increases the joint resistance R_v , heat losses and therefore the temperature of the joint, which in turn accelerates the chemical reaction producing the film build-up. This “vicious circle” of film build-up, heat loss and joint temperature can ultimately cause the busbar joint to fail totally as a result of overheating.

2.4.3.1. Sources of heat, internal and external heat

Contact temperature rise is promoted by both internal and external heat. The internal heat is generated by energy losses in the conductor, compounded by the constriction and impurity resistances. The external heat results from ambient conditions. In the case of indoor applications, heat dissipation by radiation or convection may be insufficient, or the busbar joints may be heated additionally when installed close to metal melting installations or chemical production equipment. Outdoors, exposure to sunshine increases temperature levels.

2.4.3.2. Overtemperature

According to [2], the temperature of the conductive contact surfaces inside the joint are measurably higher than those on the external surfaces of the busbars. It can happen that no overtemperature is apparent on the external surfaces, while the temperature inside the joint is so high that aging is accelerated.

3. Economic and ecological aspects

3.1. Technical reliability and maintenance of bolted busbar joints

A joint's technical reliability and the required maintenance work is directly related to its resistance factor k_u . Busbar joints are technically reliable, requiring little or no maintenance, if they age slowly enough over an economic service life of 20 to 40 years (outdoors or indoors) that self-destruction through overheating does not occur.

The economics of most bolted busbar connections can be enhanced by lowering the energy losses caused by contact heating over the above period. For a given electrical load this presumes that the resistance factor k_u can be improved, which is precisely what the connecting element MC-SEALconTACT does.

The functional properties of MC-SEALconTACT also have positive effects on system reliability and availability by increasing the amount of operating time in relation to maintenance time.

Besides the immediate economic aspects, ecology is also a consideration. In Western Europe alone there are billions of these busbar joints; unnecessary energy losses at each of them obviously increase the consumption of valuable fossil fuels.

This raises the amount of harmful gases emitted to the atmosphere, thus contributing to pollution and global warming. Use of the connecting element MC-SEALconTACT helps to minimize these harmful effects.

3.2. State-of-the-art bolted busbar joints

Large, flat contact surfaces like those obtained simply by overlapping busbars do not provide dependable, predictable conduction of current. The actual points of contact at which current flows are both few and randomly distributed. As time goes by, even they are reduced in size or eliminated by impurity film build-up. Ultimately the joint can fail totally as a result of overheating. The immense damage caused can be prevented only by periodic overhaul of the busbar joints, which is both costly and time-consuming.

3.3. Bolted busbar joints with the connecting element MC-SEALconTACT

3.3.1. Functional properties of the connecting element MC-SEALconTACT

3.3.1.1. Contact module with torsion-spring louvers

The contact module of MC-SEALconTACT with integrated torsion-spring louvers provides defined contact at a large number of conductive contact areas. The shape and action of the torsion-spring louver enables it to penetrate impurity films, thus permitting efficient contact using bare, untreated busbars.

Renewed build-up of impurity film at the conductive contact areas, i.e. the torsion-spring louvers, is impossible. The high contact pressure applied by each louver affords full-area contact, thus precluding any such build-up.

3.3.1.2. Grooved support module

The support module's main function is to limit the compression of the torsion-spring louvers to ensure optimal contact. Providing the module with grooves adds an effect similar to that of the louvers

themselves, namely that the peaks between the grooves break through the impurity films and bite into the busbars to ensure even contact between the two surfaces.

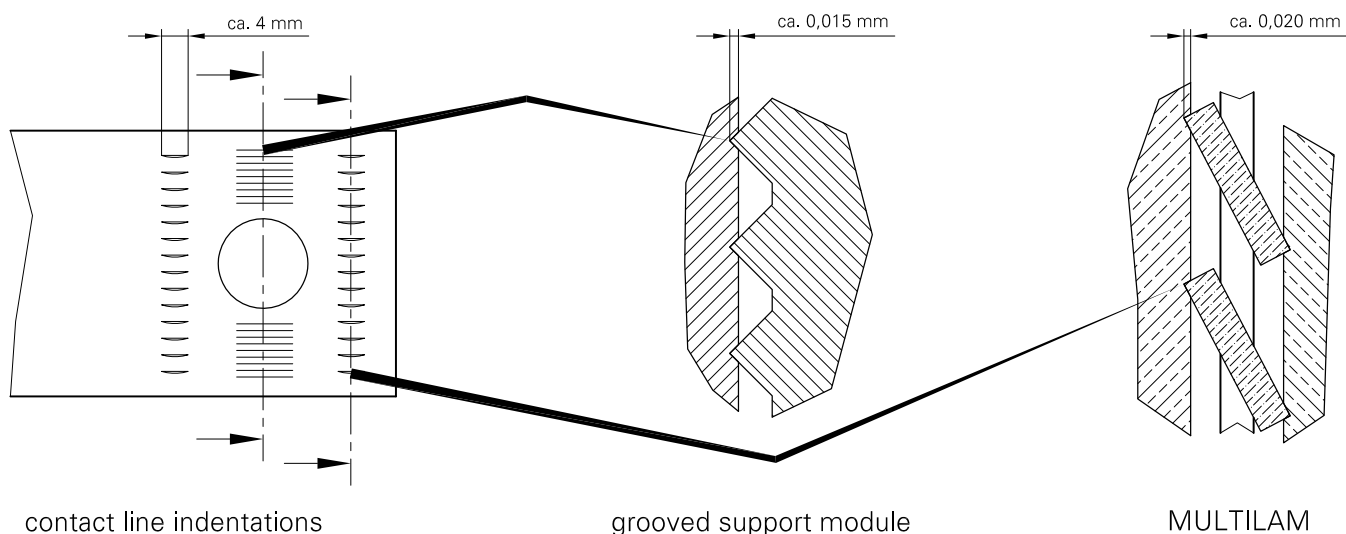

e.g. Oxide film of Al-busbars
2 nm (Mean value) = 0,000002 mm

Figure 2
Penetration of the impurity film by the grooved support module and the MULTILAM

3.3.1.3. Sealing frame for the contact and support modules

The contact and support modules of the connecting element MC-SEALconTACT are sealed hermetically against the ambient atmosphere, and thus against moisture and harmful gases. This provides another effective barrier against impurity film build-up. Where there is no such film build-up, the resistance factor k_u (and therefore joint quality) remains constant over a long period of time. Energy losses remain constant at a low level as well.

factors tend to become unstable fairly quickly. For instance, a joint with an original resistance factor of $k_{u0} = 6$ may fail totally in a matter of months.

Figure 3 presents figures for various surface pretreatment practices used to make up busbars joints without MC-SEALconTACT. Figure 4 shows a virtually identical initial resistance factor of $k_{u0} = 1,5$ of busbars with MC-SEALconTACT for the material pairs Cu-Cu, Al-Al and Cu-Al, cleaned and uncleaned, indoor duty, outdoor duty, and exposure to rainwater.

3.4. Comparison of the resistance factors of bolted busbar joints with and without MC-SEALconTACT

3.4.1. Initial resistance factor k_{u0}

Investigations described in [2] demonstrate that the long-term resistance factor $k_u(t)$, as shown in Figure 5, depends largely on the initial resistance factor k_{u0} . Joints with high original resistance

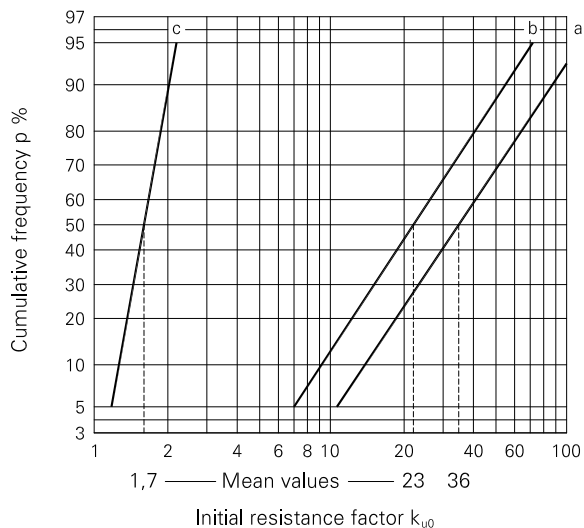

Figure 3
Empirically determined initial resistance factors k_{u0} of joints without MC SEALconTACT.

- Curve a: uncleaned
- Curve b: cleaned optimally and then touched by a dirty hand
- Curve c: cleaned optimally

3.4.2. Long-term resistance factor k_u (t)

Shown in Figure 5

3.4.2.1. Without connecting element

The curves were determined experimentally [2] for indoor applications. The bandwidth between the two curves was determined by two different variables:

- different initial resistance factors, k_{u0}
- different temperature combinations

If the electrical loss costs are to be minimized or kept at an economically justifiable level, the joint should be overhauled as soon as its resistance factor k_u reaches 3,5.

Otherwise it would enter the area of exponentially rising resistance factors and run the risk of total failure.

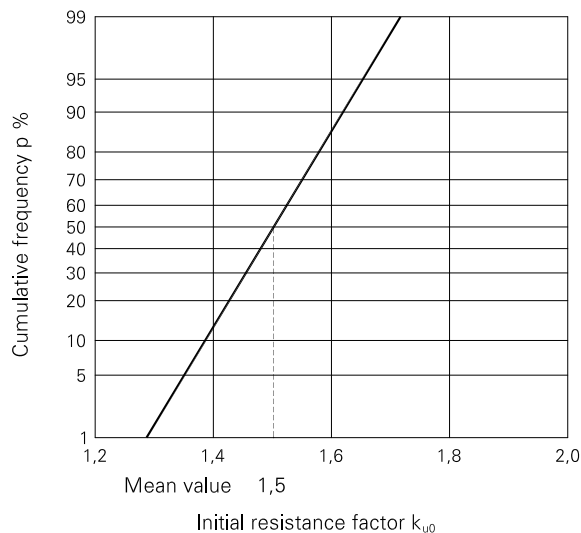

Figure 4
Empirically determined initial resistance factors k_{u0} of joints with MC SEALconTACT.

- of cleaned and uncleaned busbars
- Cu-Cu, Al-Al, Cu-Al
- indoor duty, outdoor duty, exposure to rainwater

Determination by measurement of the resistance factor in energy installations

- The resistance factor can be determined directly in the installation by measuring the joint resistance with a micro-ohmmeter developed specially for this purpose.

3.4.2.2. With connecting element

These curves apply to both indoor and outdoor applications. The forecast long-term behaviour is based on extensive environmental simulations employing accelerated aging (Appendix) and on the functional properties of torsion-spring louvers as determined by many years of actual service. In outdoor applications, the sealing frame of the contact and support modules is doubly important.

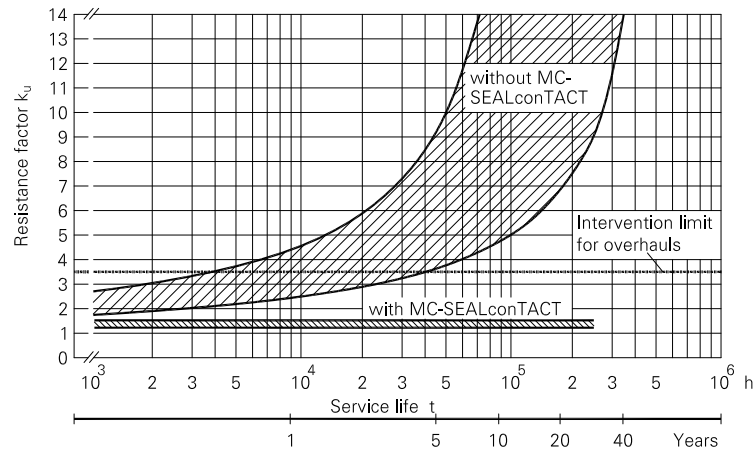

Figure 5
Long-term resistance factor $k_u(t)$

3.5. Prospective energy cost savings at busbar joints with the connecting element MC-SEALconTACT in indoor applications

Figure 6 shows the comparative costs of the heat losses caused by the contact resistance $R_{i,j}$. The curves do not include the heat losses in the busbars caused by the internal resistance R_b .

The calculations are based on a busbar joint that occurs very frequently in power distribution systems.

Costs of the heat losses of a busbar connection

Busbar material:	aluminium, bare
Dimensions:	40 mm x 10 mm
Current:	600 A, constant
Initial resistance factor, k_{u0} :	1,5
Long-term resistance factor, $k_u(t)$:	averages from Figure 3
Service period:	up to 10 years
Energy price:	€ 0.08 / kWh

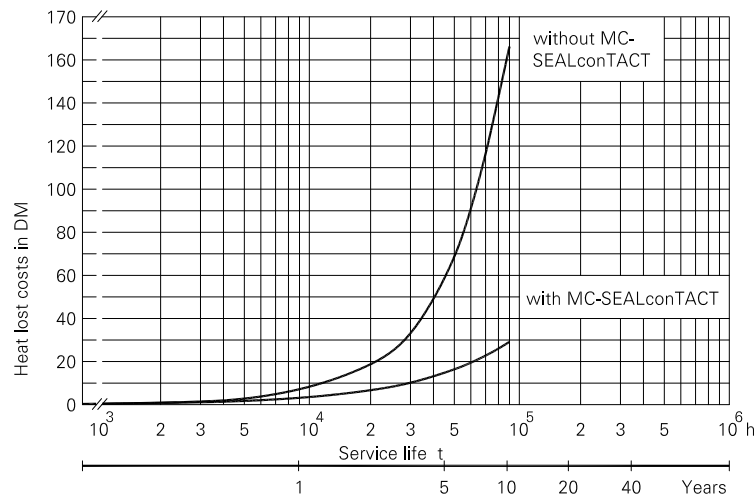

Figure 6
Prospective energy cost savings achievable with the connecting element MC-SEALconTACT

4. Summary

Comparison of bolted busbars joints with and without the MC-SEALconTACT connecting element:

Busbars joints without MC-SEALconTACT	Busbars joints with MC-SEALconTACT
Time consuming cleaning of the busbars necessary, often at poorly accessible locations.	Cleaning of busbars not necessary
In practice, cleaning is hardly even thorough enough, which means poor initial resistance factors	Good initial resistance factors, regardless of bar material or ambient conditions
Surface pretreatment required in nearly all applications	Surface pretreatment not necessary
Rising resistance factor after only a few months, i.e. higher energy losses	Installation economics: low resistance factor over a long duty period (stable long-term behaviour), i.e. minimal energy losses
Risk of breakdowns, or else periodic servicing of the bolted joints	High service reliability. No servicing of bolted joints required
Relatively short service life	Substantially prolonged service life

These positive effects become even more visible in outdoor applications or chemical plants where the atmosphere is laden with

chemically aggressive substances, especially in combination with average humidity levels.

5. Literature references

[1] A. Erk/M. Schmelzle
Grundlagen der Schaltgerätetechnik
Springer-Verlag/Berlin/Heidelberg/New York 1974

[2] H. Böhme
Mittelspannungstechnik
Verlag Technik/Berlin/Munich 1992

6. Appendix

Testing of the long-term resistance factor $k_u(t)$ of busbar joints with the connecting element MC SEALconTACT

To date, the hermetic sealing and electrical quality have been investigated with accelerated aging or under special conditions as follows:

- IEC 68-2-2 and DIN IEC 68 Part 2-2
Basic environmental testing procedures Part 2,
Test B: Dry heat
- IEC 68-2-3 and DIN IEC 68 Part 2-3
Electrical engineering, basic environmental testing procedures,
Test: Damp heat, steady state
- DIN VDE 0212 Part 52
Fittings for overhead transmission lines and switchgear installations, alternating load tests
- Change of temperature in air, indoors
Temperature range: - 20 ° to +110 °C
Heat-up time: t = 65 min.
Cool-down time: t = 130 min.
Duration: t = 10 days
- Test of sealing capacity as a function of temperature and bearing pressure, standard atmosphere, indoors
at t = 80°C duration t = 72 h
t = 100°C t = 72 h
t = 120°C t = 72 h

- Test of sealing capacity with extremely rough surfaces of the bare busbars, standard atmosphere, indoor busbars with surface roughness of N8 to N10
- IEC 68-2-52 resp. DIN IEC 68 part 2-52
Saline fog test
Period: t = 30 days
- **Long-term testing indoors, outdoors and with exposure to rainwater.**
In tests with bare, uncleaned copper and aluminium busbars and also with the critical metal combination copper / aluminium no deterioration of the contact resistance, respectively, the resistance factor has been observed up to now in the elapsed testing period of 24'000h compared to the new condition.
Based on the prevailing state of knowledge regarding the time-dependent variation of contact quality in high-current contacts, in particular those with MULTILAM bands, it is possible to extrapolate to a service life of over 200'000h (equivalent to 20 years) without exceeding any valid limiting parameters. These tests are still continuing in order to substantiate the values given in the diagram "long-term resistance factor" which are based on extensive accelerated time testing.



■ Stäubli Units ○ Agents

Global presence of the Stäubli Group

www.staubli.com