

Part number

CAP 10 LS2



Surface mounting housing, C-TYPE series, with 1 lever, Pg21 x 2 cable entry, size "57.27", high construction, with metal cover

Product description

Product type	surface mounting housing
Series	C-TYPE
Closing type	with 1 lever
Size	size "57.27"
Cable entry	Pg21 x 2
Specification	high construction, with metal cover

Technical data

IP degree of protection	IP65
--------------------------------	------

Further technical details

Weight	420,00 g
Operating temperature range (min, max)	-40 °C...+125 °C

Approvals / Standards

Certifications	DNV-GL, BV
-----------------------	------------

General ordering information

EAN13 code	8015747007740
-------------------	---------------

Packaging Information

Packaging length	475,00 mm
Packaging height	200,00 mm
Packaging width	150,00 mm
Packaging weight	4,27 kg
Packaging volume	14,25 dm ³
Packaging description	Carton box
Packaging quantity	10 Pcs
Packaging EAN code	8015747236379
Sub-packaging weight	2,14 kg
Sub-packaging description	Plastic packaging
Sub-packaging quantity	5 Pcs
Sub-packaging EAN barcode	8015747236386

Part number

CAP 10 LS2



Catalogue drawings

CHP L - CAP L MHP L - MAP L

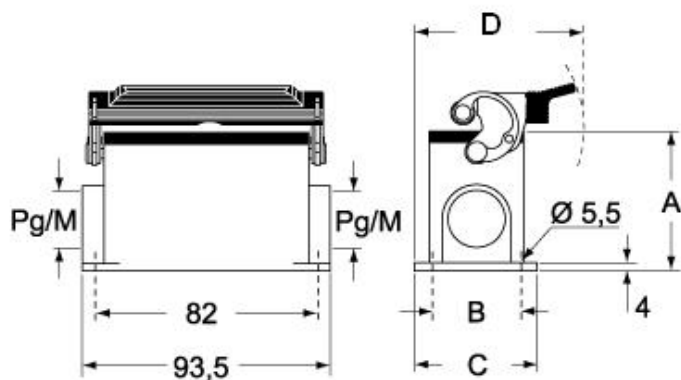

CHP LS - CAP LS MHP LS - MAP LS

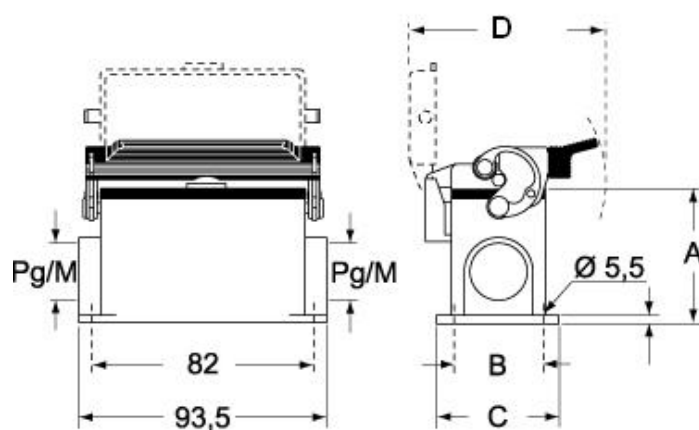

Notes

Dimensions shown in mm are not binding and may be changed without notice.