

Diritti riservati All rights reserved

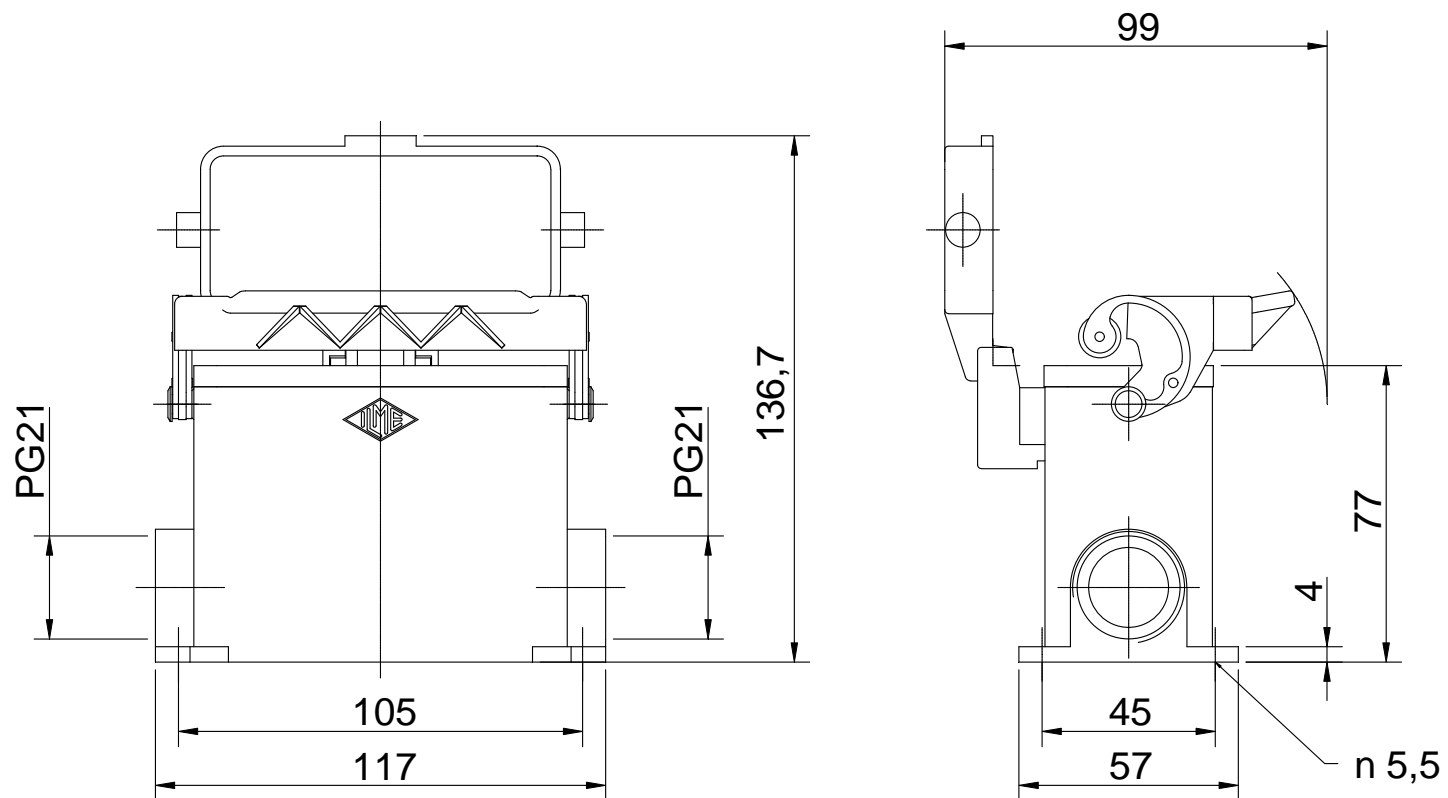

Date 04.01.2007	<b>CAP 16 LS2</b>		Scale
Sign.	surface mount. h. 1 lev.+cover 2xPG21		1:2
			