

Diritti riservati All rights reserved

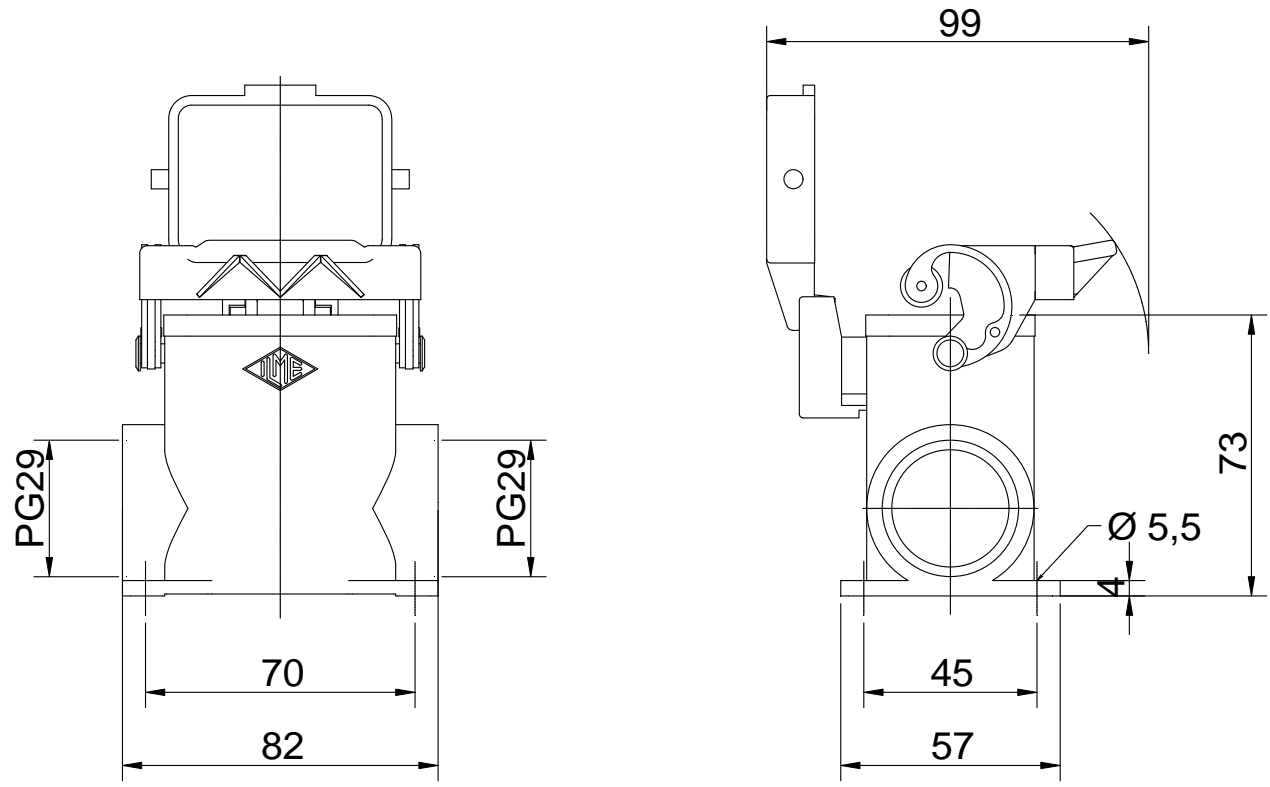

Date 04.01.2007	CAP 06 LS229		Scale
Sign.	surface mount. h. 1 lev.+cover 2xPG29		1:2