

Diritti riservati All rights reserved

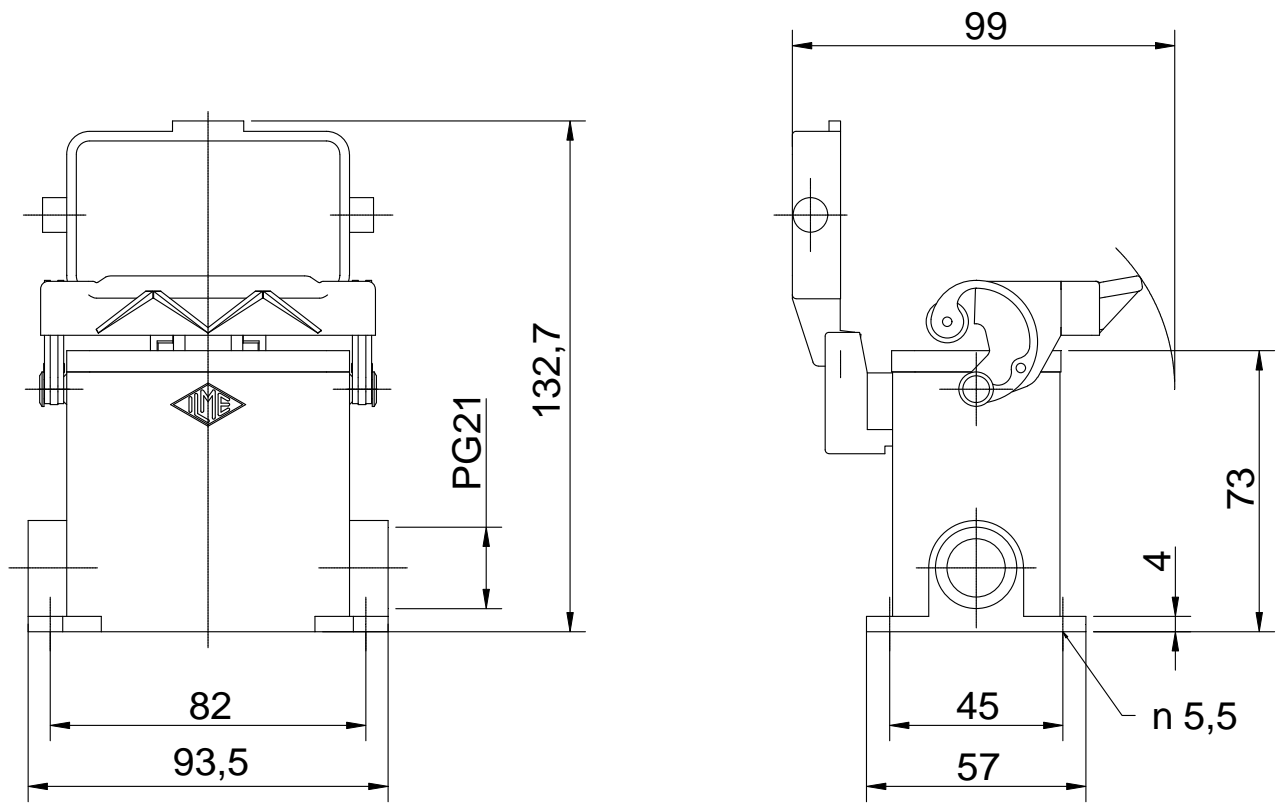

Date 04.01.2007	CAP 10 LS		Scale
Sign.	surface mount. h. 1 lev.+cover PG21		1:2
			