

Part number

MHP 32 LS40



Surface mounting housing, C-TYPE series, with 1 lever, M40 cable entry, size "77.62", with metal cover

Product description

Product type	surface mounting housing
Series	C-TYPE
Closing type	with 1 lever
Size	size "77.62"
Cable entry	M40
Specification	with metal cover

Technical data

IP degree of protection	IP65
--------------------------------	------

Further technical details

Weight	795,00 g
Operating temperature range (min, max)	-40 °C...+125 °C

Approvals / Standards

Certifications	DNV-GL, BV
-----------------------	------------

General ordering information

EAN13 code	8015747055017
-------------------	---------------

Packaging Information

Packaging length	290,00 mm
Packaging height	140,00 mm
Packaging width	215,00 mm
Packaging weight	3,67 kg
Packaging volume	8,73 dm ³
Packaging description	Carton box
Packaging quantity	4 Pcs
Packaging EAN code	8015747211161
Sub-packaging weight	0,92 kg
Sub-packaging description	Plastic packaging
Sub-packaging quantity	1 Pcs
Sub-packaging EAN barcode	8015747055024

Part number

MHP 32 LS40



Catalogue drawings

CHP L CAP L - MHP L MAP L

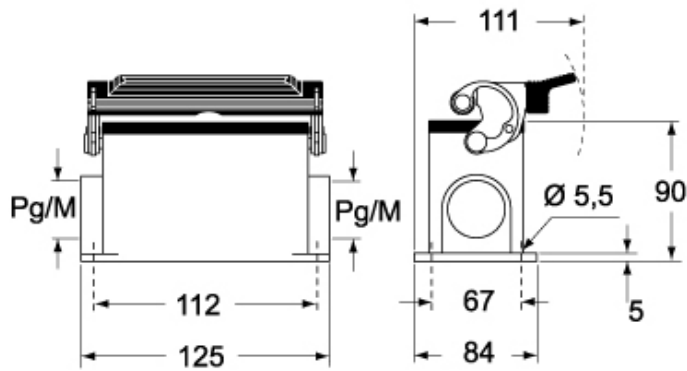

CHP LS CAP LS - MHP LS MAP LS

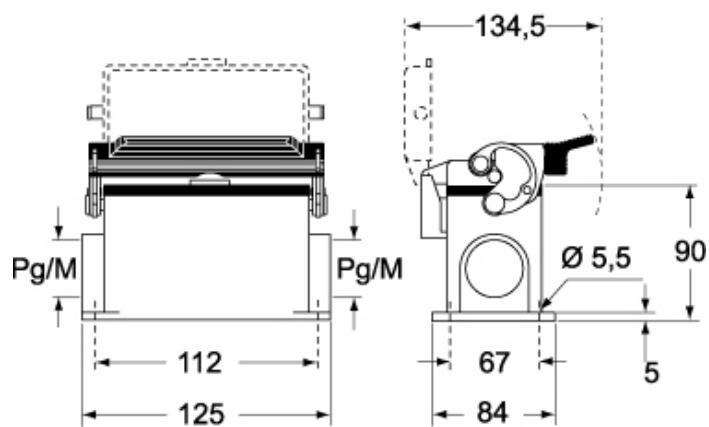

Notes

Dimensions shown in mm are not binding and may be changed without notice.