

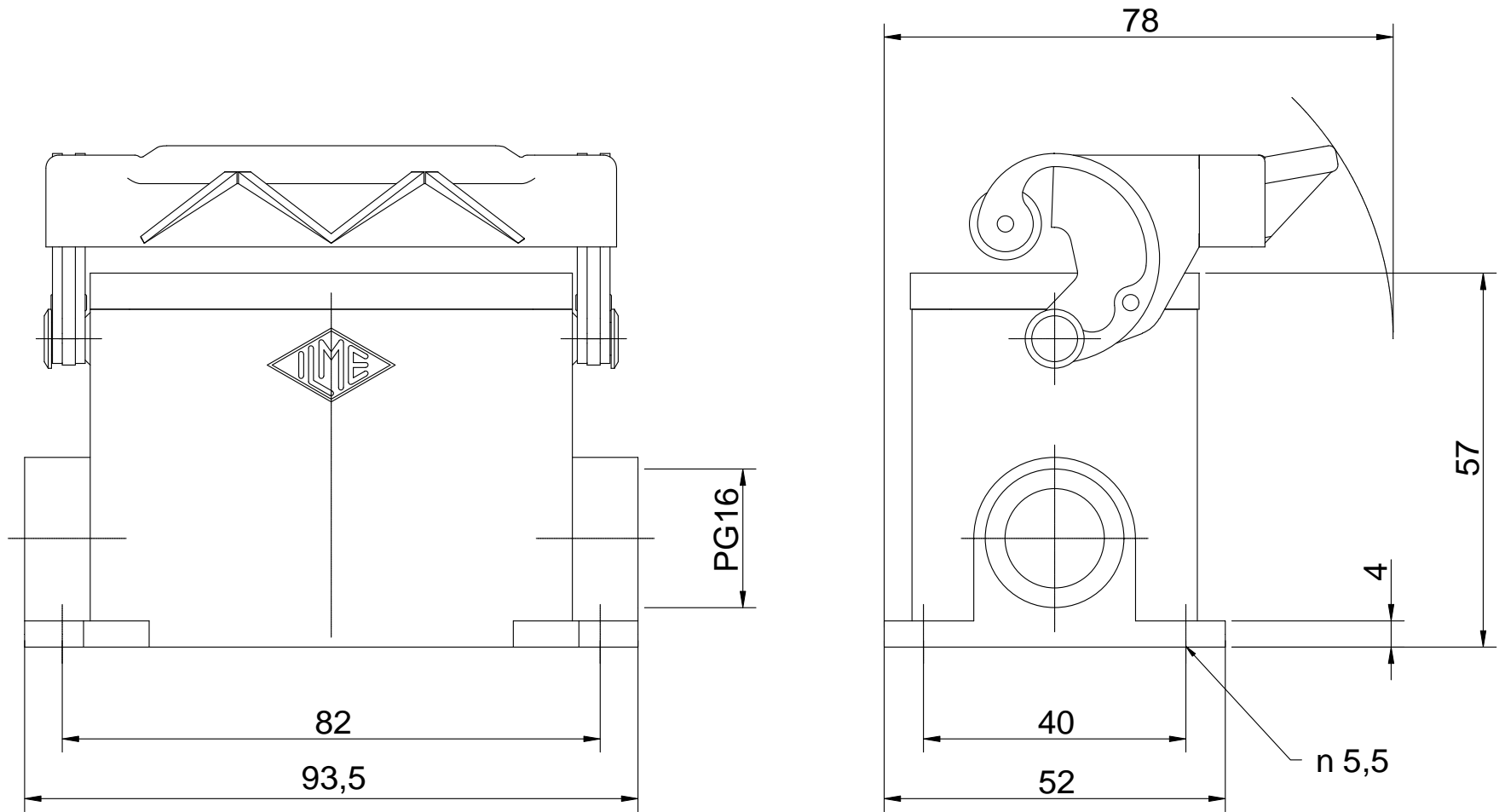

Diritti riservati All rights reserved



Date 10.01.2007	CHP 10 L2	Scale	
Sign.	surface mounting h. 1 lev. PG16	1:1	