

Part number

CKAX 03 IA



Brief description:

angled bulkhead housings with single lever, size "21.21", without cable gland, metal version, IP44, IP66/IP67 degree of protection with CKR 65 kit or CKR 65 D kit.

Product description		Approvals / Standards	
Version	Metallic type	Quality mark	SAIS type: 12, (type 4/4X only with kit CKR 65 or CKR 65 D),  , EAC
Series	Angled mounting housings with 1 lever	Conformity	CQC, CE
Product type	with stainless steel lever	General ordering information	
Variant	without cable gland	EAN13 code	8015747027533
Family	CKA metal enclosures	Tariff number	85369095
Size	size "21.21"	Packaging Information	
Technical data		Packaging length	330,00 mm
Operating temperature range (min, max)	-40°C ... +125°C	Packaging height	170,00 mm
Material	metal	Packaging width	230,00 mm
IP degree of protection	IP44 (IP66/IP67/IP69 with CKR 65/CKR 65 D kits)	Packaging weight	5,56 kg
Further technical details		Packaging volume	12,90 dm ³
Weight	48,00 g	Packaging description	Carton box
		Packaging quantity	100 Pcs
		Packaging EAN code	8015747233996
		Sub-packaging length	100,00 mm
		Sub-packaging height	58,00 mm
		Sub-packaging width	145,00 mm
		Sub-packaging weight	0,56 kg
		Sub-packaging volume	0,84 dm ³
		Sub-packaging description	Carton box
		Sub-packaging quantity	10 Pcs
		Sub-packaging EAN barcode	8015747027540

Part number

CKAX 03 IA



Catalogue drawings

Catalogue drawings

CKA IA

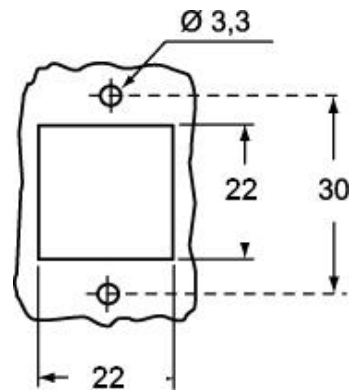
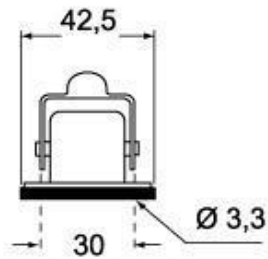
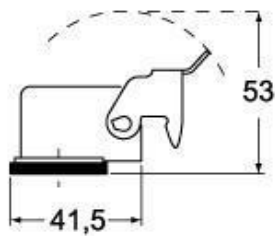

CKAX IA

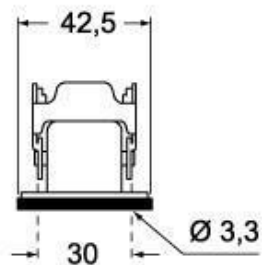
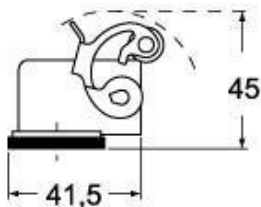

CKA IAPS (CKA APS) MKA - IAP (MKA AP)

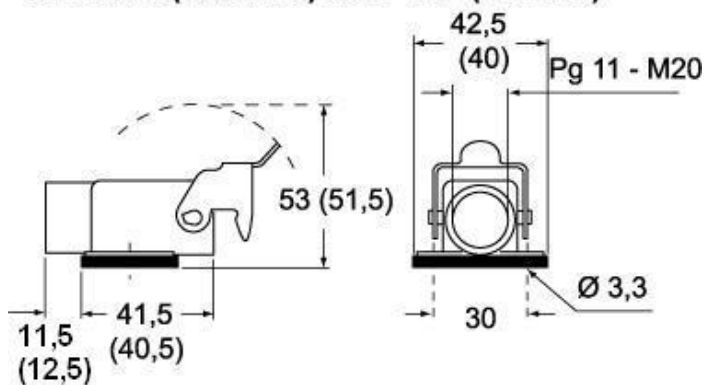

CKAX IAPS (CKAX APS) - MKAX IAP (MKAX AP)

